

Notes on Dupuytren Measurement systems
Charles Eaton MD Dupuytren Research Group Jan 2018

Contents

Published.....	3
1936 Meyerding: Generic Objective Profile	3
1946 Einarsson: Generic Objective Profile	3
1948 Skoog: Generic Objective Profile	3
1958 Iselin: Generic Objective Profile	4
1958 McIndoe and Beare: Generic Objective Profile	4
1959 Howard: Generic Objective Profile	5
1965 Davis: Specific Objective Profile (Postoperative)	5
1968 Tubiana: Generic Objective Profile.....	5
1968 Tubiana: Specific Objective Profile (Postoperative)	6
1971 Honner: Generic Objective Profile (Postoperative).....	6
1980 Johnson: Specific Objective Profile (Diagnostic)	6
1980 Legge & McFarlane: Specific Objective Profile (Outcome Prediction)	7
1991 Mäkelä: Specific Objective Profile (Postoperative)	7
1995 Sollerman: Generic Objective Profile (General Hand Function).....	8
1998 Woodruff: Specific Objective Profile (Operative time prediction)	9
1998 Chung: MHQ: Generic Objective Profile (General Hand Function)	9
2001 Dias: (PEM): Specific Objective Profile (Postoperative)	14
2006 Dias: (PEM): Specific Objective Profile (Postoperative)	16
2016 Hindocha: Specific Objective Profile (Recurrence Prediction)	17
2006 Stam: Generic Objective Profile (dorsal digital goniometer design)	17
2006 Van Rijssen: Specific Objective Profile (Recurrence definition)	17
2007 Kato: Generic Objective Profile (Comparison of goniometers).....	18
2007 Zyluk: Specific Objective Profile (Functional effect of surgery).....	18
2008 Hindocha: Generic Objective Profile (Revised Tubiana System)	18
2008 Macionis: Generic Objective Profile (Tracing technique).....	19
2009 Smith: Generic Objective Profile (Photographic Goniometry)	19
2009 Hurst: Specific Objective Profile (Immediate treatment outcome)	19
2009 Degreeef: Generic Objective, Subjective Review (Compare DASH, AMA Guides)	20

Notes on Dupuytren Measurement systems
Charles Eaton MD Dupuytren Research Group Jan 2018

2011 Beaudreuil: Generic Subjective Profile (URAM)	20
2011 Budd: Quickdash: Generic Subjective Profile	20
2011 Engstrand: Generic Objective Profile (Goniometry validation)	23
2011 Jerosch-Herold: Generic Objective, Subjective Review (DASH vs.Goniometry).....	23
2011 Pervulesko: Specific Objective Profile (Self-diagnosis).....	23
2011 Trybus: Generic Subjective Profile	24
2011 Witthaut: Specific Objective, Subjective Review (Subjective vs. goniometric improvement) .	24
2012 Descatha Specific Subjective Profile Risk prediction vs. perceived manual exertion history (RPE)).....	25
2012 Matton and Eaton: Generic Objective Profile (Wire Goniometer).....	26
2013 Macionis: Generic Objective Profile (Paper goniometer)	27
2013 Ball: Generic Objective, Subjective Review	28
2013 Bot: Generic Subjective Review (Web vs paper forms for self-reported hand data).....	29
2013 Gu: Generic Subjective Profile (speculated disability based on hand pictures).....	29
2013 Kan: Specific Objective Review (Definitions of recurrence)	29
2013 Pearl: Generic Subjective Profile Generic (3 dimensional assessment)	30
2013 Van Vliet: Generic Subjective Review.....	30
2013 Wilburn: Generic Subjective Review (QOL vs. activity limitations)	31
2013 Mohan Generic Subjective Profile (Southampton Dupuytren’s Scoring Scheme)	31
2013 Kan: Specific Objective Profile (Recurrence)	31
2014 Westacott Generic Objective Profile (Visual record)	32
2015 Akhavani: Generic Objective Review.....	32
2015 Rodrigues: Generic Subjective Review	32
Unpublished.....	32
Eaton: Generic Objective Profile (PROM; Tracing).....	32
Eaton: Generic Objective Profile (PROM; Self-reported online goniometer)	33
Lenze: Generic Objective Profile (PROM; Printed paper protractor)	33
Lubahn: Generic Objective Profile (PROM; Analogue wall clock as protractor)	34
Raskin: Generic Objective Profile (Curved table-top test)	34
References	35

Notes on Dupuytren Measurement systems
Charles Eaton MD Dupuytren Research Group Jan 2018

Tags:

- Timeline: *Generic vs Specific* (Pretreatment, Outcome, Recurrence)
- Perspective: *Objective* (Angles, Nodules, # Digits) vs *Subjective* (Activities, QOL)
- Paper: Profile vs Review

Published

1936 Meyerding: [Generic](#) | [Objective](#) | [Profile](#)

https://Dupuytren.org/DupPDFs/1936_Meyerding.pdf

- 0 indicates that there is no deformity other than unnatural thickening of the palmar fascia and wrinkling of the skin and that there is no contracture of a finger
- 1 indicates, in addition to the preceding conditions, definite contracture of one finger, but not more than 60 degrees of flexion in any one joint (the hand can grasp, but there is not full extension of one finger)
- 2 indicates involvement of more than one finger, with definite contracture and inability to extend more than 60 degrees
- 3 indicates contracture of two or more fingers and contracture of 90 degrees or more of one (the thumb and index finger may be opened and still be useful, although the hand as a whole cannot be opened for grasping)
- 4 indicates more or less contracture of all the digits, and the hand cannot be opened or the thumb fully extended (some of the articulations may be in acute flexion and ankylosed, and a finger-tip may remain in contact with the palm).

1946 Einarsson: [Generic](#) | [Objective](#) | [Profile](#)

https://Dupuytren.org/DupPDFs/1946_Einarsson.pdf

- Grade 0: Nodules in the palmar aponeurosis, sometimes involving the skin, but no flexion deformity.
- Grade I: In addition to the conditions already mentioned, major or minor flexion deformity of one finger only.
- Grade II: Flexion deformity of more than one finger, nowhere attaining 60°.
- Grade III: Flexion deformity of more than one finger, exceeding 60° in at least one.
- Grade IV: Major or minor flexion deformity of all fingers.

1948 Skoog: [Generic](#) | [Objective](#) | [Profile](#)

https://Dupuytren.org/DupPDFs/1948_Skoog08.pdf

(Modification of Meyerding)

- Grade I. Thickening of the palmar aponeurosis with major or minor flexion deformity of one finger only.
- Grade II. Flexion deformity of more than one finger, nowhere attaining 60 degrees.

Notes on Dupuytren Measurement systems
Charles Eaton MD Dupuytren Research Group Jan 2018

- Grade III. Flexion deformity of more than one finger, exceeding 60 degrees in at least one joint.
- Grade IV. Major or minor flexion deformity of all fingers.

[1958 Iselin: Generic | Objective | Profile](#)

https://Dupuytren.org/DupPDFs/1967_Iselin.pdf

- First Degree: contracture of the metacarpophalangeal joint, nodules not extending laterally or distal to proximal phalanx.
- Second Degree: contracture of the proximal interphalangeal joint, lateral digital nodules
- Third degree: flexion contractures of all phalanges.
- Fourth Degree: contracture of the metacarpophalangeal and proximal interphalangeal joints with hyperextension of the distal interphalangeal joint

[1958 McIndoe and Beare: Generic | Objective | Profile](#)

https://Dupuytren.org/DupPDFs/1958_McIndoe.pdf

- Stage I. There is involvement of the palmar fascia only. The fingers are not contracted and function is normal. This is the ideal stage for operation and the surgeon should emphasise to the patient that nothing is to be gained by waiting for the condition to progress.
- Stage II. There is a minor contracture of one or more fingers, or finger bands are palpable without actual contracture. In addition, there is minor dimpling of the palmar skin.
- Stage III. Major finger contracture has occurred and there is extensive involvement of skin. The finger joints remain normal. Operation at this stage still gives an excellent result. but a lengthy period of postoperative physiotherapy will be necessary before full function is regained.
- Stage IV. Secondary changes have occurred in the joints of the affected fingers. The normal action of the lumbricals and interossei may have become disturbed so as to hyperextend the terminal phalanges, a symptom of serious prognostic significance. A further clinical feature of this stage is the spread of the fibrosis to surround the distorted finger, producing the so-called "frozen finger." Normal function can never be regained in hands which reach Stage IV.

Notes on Dupuytren Measurement systems
Charles Eaton MD Dupuytren Research Group Jan 2018

1959 Howard: Generic | Objective | Profile

https://Dupuytren.org/DupPDFs/1959_Howard.pdf

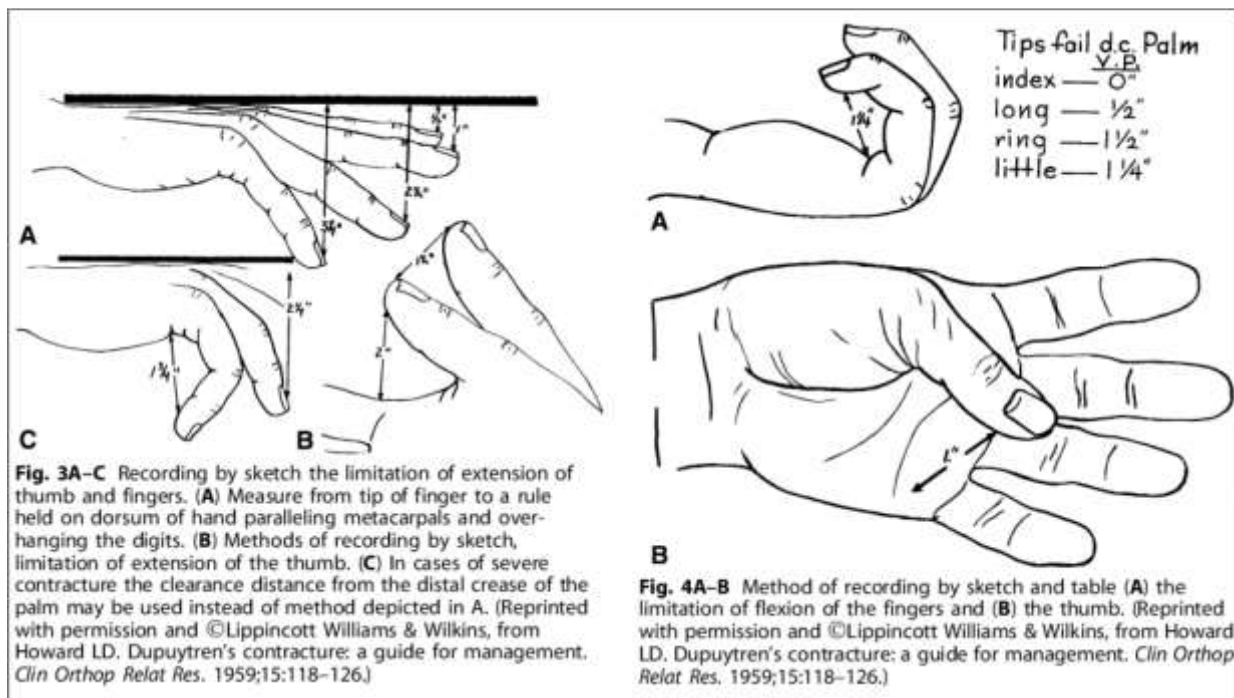

1965 Davis: Specific | Objective | Profile (Postoperative)

https://Dupuytren.org/DupPDFs/1965_Davis.pdf

- Good: full active movement, with nails flexing to the distal palmar crease and extending to 180°. No edema. Full use of hand.
- Fair: subtotal active movement, with nails spreading from midpalm to 170°. No edema. Full use of hand.
- Poor: fingertips extending from the heel of the palm to 160°. Slight edema. Hand not recovered, but can be used for all light duty.
- Bad: anything less or with complications.

1968 Tubiana: Generic | Objective | Profile

https://Dupuytren.org/DupPDFs/1968_Tubiana.pdf

Assessment of the most involved digit

- Stage 0 Disease, but no contracture
- Stage I Overall contracture between 0 and 45 degrees
- Stage II Overall contracture between 45 and 90 degrees
- Stage III Overall contracture between 90 and 135 degrees
- Stage IV Overall contracture greater than 135 degrees

Notes on Dupuytren Measurement systems
Charles Eaton MD Dupuytren Research Group Jan 2018

- Modifiers:
 - P: Palmar disease
 - H: DIP hyperextension
 - T: more than one involved digit

Summary number for hand = sum of numeric grade for each digit. Each digit is assigned a value

- 0.5: Disease, but no contracture
- 1: Overall contracture between 0 and 45 degrees
- 2: Overall contracture between 45 and 90 degrees
- 3: Overall contracture between 90 and 135 degrees
- 4: Overall contracture greater than 135 degrees

1968 Tubiana: Specific | Objective | Profile (Postoperative)

https://Dupuytren.org/DupPDFs/1968_Tubiana.pdf

- Coefficient of improvement (Tubiana):
 $((\text{Preop Tubiana number}) - (\text{Postop Tubiana number})) / \text{Preop Tubiana Number}$
- Coefficient of improvement (Thomine):
 $((\text{Preop composite contracture}) - (\text{Postop composite contracture})) / \text{Preop composite contracture}$

1971 Honner: Generic | Objective | Profile (Postoperative)

http://www.springerreference.com/index/doi/10.1007/SpringerReference_40904

- Excellent-Full flexion and extension of the fingers, full function, no recurrences.
- Good-Slight limitation of flexion or extension. Recurrence if present is too slight to interfere with normal activity.
- Fair-Limitation of flexion or extension with joint stiffness. Recurrence or extension limiting function slightly.
- Poor-No improvement on the initial range of movement or function. Recurrence or extension causing serious loss of function.

1980 Johnson: Specific | Objective | Profile (Diagnostic)

https://Dupuytren.org/DupPDFs/1980_Johnson.pdf

Hugh Johnson sign of early Dupuytren disease: distal palmar crease widening. (Hugh Johnson=doctor & patient)

1980 Legge & McFarlane: Specific | Objective | Profile (Outcome Prediction)
https://Dupuytren.org/DupPDFs/1980_Legge_1023.pdf

Factors predicting PIP outcome:

- Finger involved
- Joint involved
- Preoperative degrees of contracture: MCP, PIP
- Number of rays involved (N)

Calculations:

- Small Finger PIP predicted final angle = $e^{(0.016 * MCP + 0.026 * PIP + 0.275 * N)}$
- Index, Middle, or Ring Finger PIP predicted final angle = $e^{(0.053 * MCP + 0.18 * PIP)}$

1991 Mäkelä: Specific | Objective | Profile (Postoperative)
https://Dupuytren.org/DupPDFs/1991_Makela.pdf



RATING	A + B
Good	0 - 2.5 cm
Fair	2.6 - 5.0 cm
Poor	5.1 - 7.5 cm
Failure	> 7.5 cm

Fig. 1 Drawing showing the method of measuring the range of movement of a finger: A = The distance by which the finger-tip fails to touch the distal palmar crease; B = The distance by which the finger-tip fails to reach the plane of the second to fifth metacarpals.

Notes on Dupuytren Measurement systems
Charles Eaton MD Dupuytren Research Group Jan 2018

1995 Sollerman: Generic | Objective | Profile (General Hand Function)
https://Dupuytren.org/DupPDFs/1995_Sollerman.pdf

Sollerman Hand Function Test Subtests	Expected Hand Function
Put key into Yale lock, turn 90°	Pulp pinch, lateral grip
Pick coins up from flat surface, put into purse mounted on wall	Pulp pinch
Open/close purse	Pulp pinch, lateral pinch
Pick up coins from purses	Pulp pinch
Lift wooden cubes over edge 5 cm in height	5-finger pinch
Lift iron over edge 5 cm in height	Transverse volar grip, hand in pronation
Turn screw with screwdriver	Diagonal volar grip
Pick up nuts	Pulp pinch, lateral pinch, tripod pinch
Unscrew lid of jar	Spheric volar grip
Do up buttons	Pulp pinch, lateral pinch
Cut modeling clay with knife and fork	Tripod pinch, diagonal volar grip
Put a tubigrip stocking on the other hand	Lateral pinch, 5-finger pinch
Write with pen	Tripod pinch
Fold paper, put into envelope	5-finger pinch, lateral pinch
Put paper clip on envelope	Pulp pinch, lateral pinch
Lift telephone receiver, put to ear	Diagonal volar grip
Turn door handle to 30°	Transverse volar grip
Pour water from pure pack	5-finger pinch
Pour water from jug	Transverse volar grip
Pour water from cup	Pulp pinch, lateral pinch

Sollerman Hand Function Test Guidelines for Scoring of Subtests	
4	The task is completed without any difficulty within 20 seconds and with the prescribed hand grip of normal quality
3	The task is completed but with slight difficulty or the task is not completed within 20 seconds but within 40 seconds, or the task is completed with the prescribed hand grip with slight divergence from normal
2	The task is completed but with great difficulty, or the task is not completed within 40 seconds but within 60 seconds, or the task is not performed with the prescribed hand grip
1	The task is performed only partially within 60 seconds
0	The task cannot be performed at all

Notes on Dupuytren Measurement systems
Charles Eaton MD Dupuytren Research Group Jan 2018

1998 Woodruff: Specific | Objective | Profile (Operative time prediction)
https://Dupuytren.org/DupPDFs/1998_Woodruff.pdf

Grade	Description	Surgery time
1	Finger contracture only, hyperextends at MCP joint, hand lies flat on table	None
2	Single finger pre-tendinous cord, MCP joint contracture only	30 minutes
3	Single finger pre-tendinous band, MCP joint and PIP joint contracture	60 minutes
4	As 3 but two-finger contracture	90 minutes
5	Finger stuck in palm, suitable only for amputation	30 minutes

1998 Chung: MHQ: Generic | Objective | Profile (General Hand Function)
https://Dupuytren.org/DupPDFs/1998_Chung.pdf

The Michigan Hand Outcomes Questionnaire (MHQ) contains 6 scales: (1) overall hand function, (2) activities of daily living, (3) work performance, (4) pain, (5) aesthetics, and (6) satisfaction with hand function. In the pain scale, high scores indicate greater pain; in the other 5 scales, high scores denote better hand performance.

The raw scale score for each of the 6 scales is the sum of the responses of each scale item. The raw score is converted to a score range from 0 to 100. The scoring equation for each of the scales is listed below.

The score for the affected hand is obtained by selecting either the right- or the left-hand score. If both hands are affected (eg, rheumatoid patients), the right- and left-hand scale scores are averaged to get the score.

Missing values in each scale may affect the validity of the scores. If 50% or more of the items in a scale are missing, then that particular scale cannot be scored. For scales with less than 50% missing, the average of the existing scale items may be imputed for the missing items. An overall MHQ score can be obtained by summing the scores for all 6 scales and divide by 6. If scores for more than 2 scales are missing, an overall MHQ score cannot be computed.

Appendix 2: Michigan Hand Outcomes Questionnaire

Instructions: This survey asks for your views about your hands and your health. This information will help keep track of how you feel and how well you are able to do your usual activities. Answer *every* question by marking the answer as indicated. If you are unsure about how to answer a question, please give the best answer you can.

I. The following questions refer to the function of your hand(s)/wrist(s) *during the past week*. (Please circle 1 answer for each question.)

A. The following questions refer to your *right* hand/wrist.

	<i>Very Good</i>	<i>Good</i>	<i>Fair</i>	<i>Poor</i>	<i>Very Poor</i>
1. Overall, how well did your <i>right</i> hand work?	1	2	3	4	5
2. How well did your <i>right</i> fingers move?	1	2	3	4	5
3. How well did your <i>right</i> wrist move?	1	2	3	4	5
4. How was the strength in your <i>right</i> hand?	1	2	3	4	5
5. How was the sensation (feeling) in your <i>right</i> hand?	1	2	3	4	5

B. The following questions refer to your *left* hand/wrist.

	<i>Very Good</i>	<i>Good</i>	<i>Fair</i>	<i>Poor</i>	<i>Very Poor</i>
1. Overall, how well did your <i>left</i> hand work?	1	2	3	4	5
2. How well did your <i>left</i> fingers move?	1	2	3	4	5
3. How well did your <i>left</i> wrist move?	1	2	3	4	5
4. How was the strength in your <i>left</i> hand?	1	2	3	4	5
5. How was the sensation (feeling) in your <i>left</i> hand?	1	2	3	4	5

II. The following questions refer to the ability of your hand(s) to do certain tasks *during the past week*. (Please circle 1 answer for each question.)

A. How difficult was it for you to perform the following activities using your *right hand*?

	<i>Not at All Difficult</i>	<i>A Little Difficult</i>	<i>Somewhat Difficult</i>	<i>Moderately Difficult</i>	<i>Very Difficult</i>
1. Turn a door knob	1	2	3	4	5
2. Pick up a coin	1	2	3	4	5
3. Hold a glass of water	1	2	3	4	5
4. Turn a key in a lock	1	2	3	4	5
5. Hold a frying pan	1	2	3	4	5

B. How difficult was it for you to perform the following activities using your *left hand*?

	<i>Not at All Difficult</i>	<i>A Little Difficult</i>	<i>Somewhat Difficult</i>	<i>Moderately Difficult</i>	<i>Very Difficult</i>
1. Turn a door knob	1	2	3	4	5
2. Pick up a coin	1	2	3	4	5
3. Hold a glass of water	1	2	3	4	5
4. Turn a key in a lock	1	2	3	4	5
5. Hold a frying pan	1	2	3	4	5

C. How difficult was it for you to perform the following activities using *both of your hands*?

	<i>Not at All Difficult</i>	<i>A Little Difficult</i>	<i>Somewhat Difficult</i>	<i>Moderately Difficult</i>	<i>Very Difficult</i>
1. Open a jar	1	2	3	4	5
2. Button a shirt/blouse	1	2	3	4	5
3. Eat with a knife/fork	1	2	3	4	5
4. Carry a grocery bag	1	2	3	4	5
5. Wash dishes	1	2	3	4	5
6. Wash your hair	1	2	3	4	5
7. Tie shoelaces/knots	1	2	3	4	5

Notes on Dupuytren Measurement systems
Charles Eaton MD Dupuytren Research Group Jan 2018

III. The following questions refer to how you did in your **normal work** (including both housework and school work) during the **past 4 weeks**. (Please circle 1 answer for each question.)

	<i>Always</i>	<i>Often</i>	<i>Sometimes</i>	<i>Rarely</i>	<i>Never</i>
1. How often were you unable to do your work because of problems with your hand(s)/wrist(s)?	1	2	3	4	5
2. How often did you have to shorten your work day because of problems with your hand(s)/wrist(s)?	1	2	3	4	5
3. How often did you have to take it easy at your work because of problems with your hand(s)/wrist(s)?	1	2	3	4	5
4. How often did you accomplish less in your work because of problems with your hand(s)/wrist(s)?	1	2	3	4	5
5. How often did you take longer to do the tasks in your work because of problems with your hand(s)/wrist(s)?	1	2	3	4	5

IV. The following questions refer to how much **pain** you had in your hand(s)/wrist(s) **during the past week**. (Please circle 1 answer for each question.)

1. How often did you have pain in your hand(s)/wrist(s)?
 1. Always
 2. Often
 3. Sometimes
 4. Rarely
 5. Never

If you answered **never** to **question IV-1** above, please skip the following questions and go to the next page.

2. Please describe the pain you have in your hand(s)/wrist(s).
 1. Very mild
 2. Mild
 3. Moderate
 4. Severe
 5. Very severe

	<i>Always</i>	<i>Often</i>	<i>Sometimes</i>	<i>Rarely</i>	<i>Never</i>
3. How often did the pain in your hand(s)/wrist(s) interfere with your sleep?	1	2	3	4	5
4. How often did the pain in your hand(s)/wrist(s) interfere with your daily activities (such as eating or bathing)?	1	2	3	4	5
5. How often did the pain in your hand(s)/wrist(s) make you unhappy?	1	2	3	4	5

Notes on Dupuytren Measurement systems
Charles Eaton MD Dupuytren Research Group Jan 2018

V. A. The following questions refer to the appearance (look) of your **right** hand during the past week.
(Please circle 1 answer for each question.)

	<i>Strongly Agree</i>	<i>Agree</i>	<i>Neither Agree Nor Disagree</i>	<i>Disagree</i>	<i>Strongly Disagree</i>
1. I was satisfied with the appearance (look) of my right hand.	1	2	3	4	5
2. The appearance (look) of my right hand sometimes made me uncomfortable in public.	1	2	3	4	5
3. The appearance (look) of my right hand made me depressed.	1	2	3	4	5
4. The appearance (look) of my right hand interfered with my normal social activities	1	2	3	4	5

B. The following questions refer to the appearance (look) of your **left** hand during the past week. (Please circle 1 answer for each question.)

	<i>Strongly Agree</i>	<i>Agree</i>	<i>Neither Agree Nor Disagree</i>	<i>Disagree</i>	<i>Strongly Disagree</i>
1. I was satisfied with the appearance (look) of my left hand.	1	2	3	4	5
2. The appearance (look) of my left hand sometimes made me uncomfortable in public.	1	2	3	4	5
3. The appearance (look) of my left hand made me depressed.	1	2	3	4	5
4. The appearance (look) of my left hand interfered with my normal social activities	1	2	3	4	5

VI. A. The following questions refer to your satisfaction with your **right** hand/wrist during the past week.
(Please circle 1 answer for each question.)

	<i>Very Satisfied</i>	<i>Somewhat Satisfied</i>	<i>Neither Satisfied Nor Dissatisfied</i>	<i>Somewhat Dissatisfied</i>	<i>Very Dissatisfied</i>
1. Overall function of your right hand	1	2	3	4	5
2. Motion of the fingers in your right hand	1	2	3	4	5
3. Motion of your right wrist	1	2	3	4	5
4. Strength of your right hand	1	2	3	4	5
5. Pain level of your right hand	1	2	3	4	5
6. Sensation (feeling) of your right hand	1	2	3	4	5

B. The following questions refer to your satisfaction with your **left** hand/wrist during the past week. (Please circle 1 answer for each question.)

	<i>Very Satisfied</i>	<i>Somewhat Satisfied</i>	<i>Neither Satisfied Nor Dissatisfied</i>	<i>Somewhat Dissatisfied</i>	<i>Very Dissatisfied</i>
1. Overall function of your left hand	1	2	3	4	5
2. Motion of the fingers in your left hand	1	2	3	4	5
3. Motion of your left wrist	1	2	3	4	5
4. Strength of your left hand	1	2	3	4	5
5. Pain level of your left hand	1	2	3	4	5
6. Sensation (feeling) of your left hand	1	2	3	4	5

Notes on Dupuytren Measurement systems
Charles Eaton MD Dupuytren Research Group Jan 2018

Please provide the following information about yourself. (Please circle 1 answer for each question.)

1. Are you right-handed or left-handed?
 - a. Right-handed
 - b. Left-handed
 - c. Both
2. Which hand gives you the most problem?
 - a. Right hand
 - b. Left hand
 - c. Both
3. Have you changed your job since you had problem with your hand(s)?
 - a. Yes
 - b. No

Please describe the type of job you did *before* you had problem with your hand(s)._____

Please describe the type of job you are doing *now*._____

4. What is your gender?
 - a. Male
 - b. Female
5. What is your ethnic background?
 - a. White
 - b. Black
 - c. Hispanic
 - d. Asian or Pacific Islander
 - e. American Indian or Alaskan Native
 - f. Other (please specify) _____
6. What is the highest level of education you received?
 - a. Less than high school graduate
 - b. High school graduate
 - c. Some college
 - d. College graduate
 - e. Professional or graduate school
7. What is your approximate family income, including wages, disability payment, retirement income, and welfare?
 - a. <\$10,000
 - b. \$10,000–\$19,999
 - c. \$20,000–\$29,999
 - d. \$30,000–\$39,999
 - e. \$40,000–\$49,999
 - f. \$50,000–\$59,999
 - g. \$60,000–\$69,999
 - h. >\$70,000
8. Is your injury covered by Workers' Compensation?
 - a. Yes
 - b. No

Notes on Dupuytren Measurement systems
Charles Eaton MD Dupuytren Research Group Jan 2018

2001 Dias: (PEM): Specific | Objective | Profile (Postoperative)
https://Dupuytren.org/DupPDFs/2001_Dias.pdf

Part one - treatment

Please put a circle around the number that is closest to the way you feel about how things have been for you. There are no right or wrong answers.

1. Throughout my treatment I have seen the same doctor:
1 2 3 4 5 6 7
Every time Not at all
2. When the doctor saw me, he or she knew about my case:
1 2 3 4 5 6 7
Very well Not at all
3. When I was with the doctor, he or she gave me the chance to talk:
1 2 3 4 5 6 7
As much as I wanted Not at all
4. When I did talk to the doctor, he or she listened and understood me:
1 2 3 4 5 6 7
Very much Not at all
5. I was given information about my treatment and progress:
1 2 3 4 5 6 7
All that I wanted Not at all

(Part two contd)

6. Generally, when I move my hand it is:
1 2 3 4 5 6 7
Flexible Stiff
7. The grip in my hand is now:
1 2 3 4 5 6 7
Strong Weak
8. For everyday activities, my hand is now:
1 2 3 4 5 6 7
No problem Useless
9. For my work, my hand is now:
1 2 3 4 5 6 7
No problem Useless
10. When I look at the appearance of my hand now, I feel:
1 2 3 4 5 6 7
Unconcerned Embarrassed & self-conscious
11. Generally, when I think about my hand I feel:
1 2 3 4 5 6 7
Unconcerned Very upset

Notes on Dupuytren Measurement systems
Charles Eaton MD Dupuytren Research Group Jan 2018

2006 Dias: (PEM): Specific | Objective | Profile (Postoperative)

https://Dupuytren.org/DupPDFs/2006_Dias.pdf



5. After your operation have you been told that you will require another operation? Yes No
6. Have you had another operation? Yes No
7. Has your finger been amputated? Yes No

Dupuytren's Study:

Your Name _____ Date

1. What was the **date** of your hand operation?
2. Was this **First** **Second** **Third** operation on this finger (s)?



3.

<p>a. Before surgery which finger (s) was bent? Please tick.</p> 	<p>b. Which finger (s) were operated on? Please tick.</p> 
---	--

4. In the first two weeks after your operation
- | | | |
|---|-----|----|
| a. Was the wound left open and allowed to heal slowly? | Yes | No |
| b. Was skin taken from (eg) arm, leg or tummy and applied to the finger? | Yes | No |
| c. Was the finger tip numb for longer than 2 days? | Yes | No |
| d. Was the wound infected and needed dressings and/or antibiotics? | Yes | No |
| e. Did the finger tip turn blue/black and cold? | Yes | No |
- | | | | | |
|---|-------|--------------|--------|-------------|
| f. Was the bent finger corrected | Fully | Almost fully | Partly | Not at all? |
|---|-------|--------------|--------|-------------|

8. **My bent finger is now:**
(If more than one finger was operated answer for the worst bent finger.)
- 1 2 3 4 5 6 7
straight unchanged worse than before

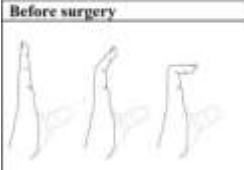
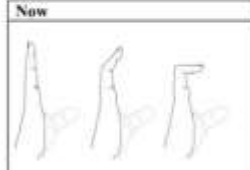
9. **How bent** was your finger?
Please tick the figure which **best matches** the **shape** of your finger.
If more than one finger was operated answer for the worst bent finger.

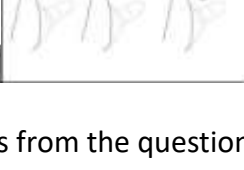
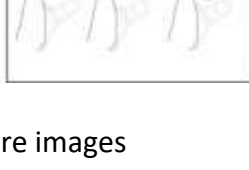
Before surgery	Now
	
	
	

Categorisation of finger deformities

The re-classification of the finger deformities from the questionnaire images

1. No contracture.
2. Mild metacarpophalangeal joint contracture only.
3. Mild proximal interphalangeal joint contracture or moderate metacarpophalangeal joint contracture.
4. Moderate proximal interphalangeal joint contracture.
5. Severe contracture of both metacarpophalangeal joint and proximal interphalangeal joint.

Notes on Dupuytren Measurement systems
Charles Eaton MD Dupuytren Research Group Jan 2018

2016 Hindocha: Specific | Objective | Profile (Recurrence Prediction)

https://Dupuytren.org/DupPDFs/2008_Hindocha_1014.pdf

4-year recurrence risk increased by 10% for each additional one of these diathesis-type factors:

- Family history in sibling or parent
- Bilateral DD
- Male gender
- Age at onset younger than 50 years
- Knuckle pads

2006 Stam: Generic | Objective | Profile (dorsal digital goniometer design)

https://Dupuytren.org/DupPDFs/2006_Stam.pdf

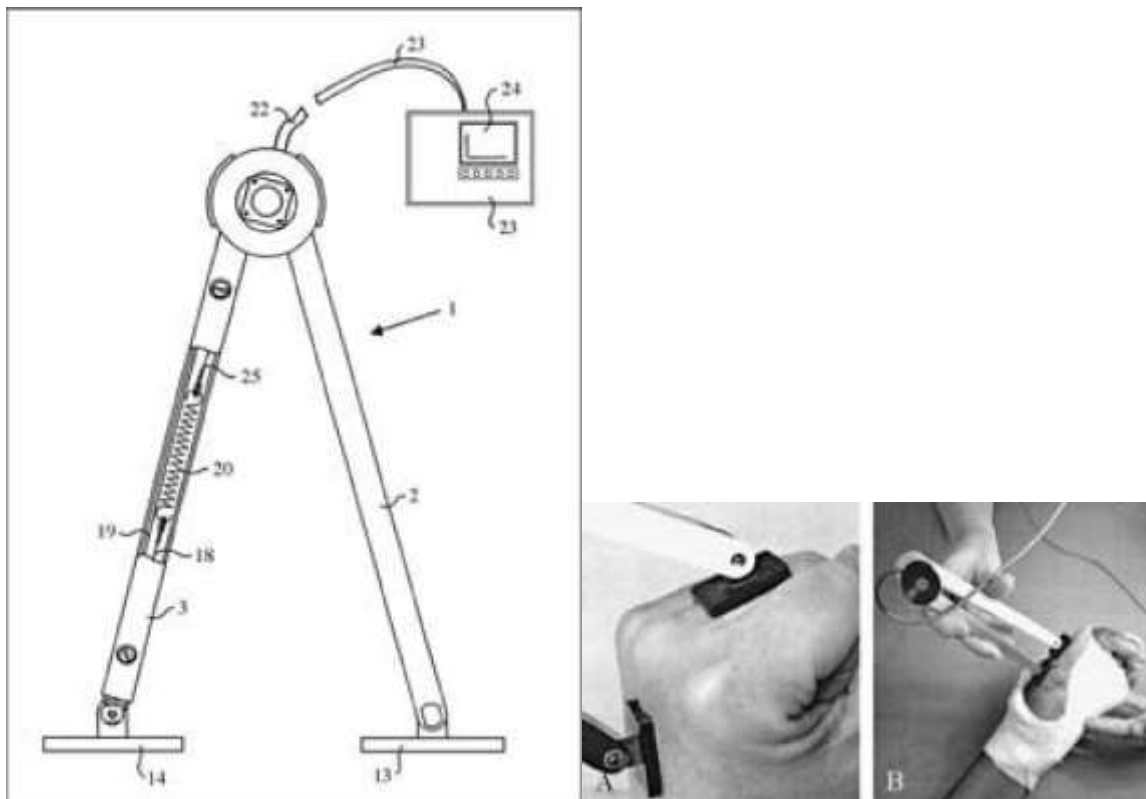

2006 Van Rijssen: Specific | Objective | Profile (Recurrence definition)

<http://www.ncbi.nlm.nih.gov/pubmed/16766101>

- Recurrence=loss of 30 degrees of passive extension compared to immediate postoperative measurement

Notes on Dupuytren Measurement systems
Charles Eaton MD Dupuytren Research Group Jan 2018

2007 Kato: Generic | Objective | Profile (Comparison of goniometers)

https://Dupuytren.org/DupPDFs/2007_Kato.pdf

- Dorsal goniometry was reliable with short armed but not long armed goniometers; lateral goniometry was reliable with all goniometers tested.

2007 Zyluk: Specific | Objective | Profile (Functional effect of surgery)

https://Dupuytren.org/DupPDFs/2007_Zyluk.pdf

Preop extension loss correlated with grip strength; grip strength did not improve with surgery; Grip strength did not correlate with number of fingers involved; DASH did not correlate with either TLE or grip strength; age at time of surgery did not correlate independently with any of these 3 measurements.

- Total loss of extension (TLE) = sum of all joint extension loss per hand
- Grip strength
- DASH

2008 Hindocha: Generic | Objective | Profile (Revised Tubiana System)

https://Dupuytren.org/DupPDFs/2008_Hindocha_1014.pdf

Criteria	Score
1 Surgical Procedures	Total #, left and right
2 Recurrences	Total #, Left and right
3 Number of digits affected	Total #, left and right
4 Number of nodules	Total #, palm or dorsal, left and right
5 Number of skin pits	Total #, left and right
6 Garrod pads	1 if present, 0 if not
7 Ledderhose	1 if present, 0 if not
8 Peyronie	1 if present, 0 if not
9 Unilateral or Bilateral	1 if unilateral, 2 if bilateral
10 Number of Tubiana Stage 1 digits	Total #, left and right
11 Number of Tubiana Stage 1 digits	Total #, left and right
12 Number of Tubiana Stage 1 digits	Total #, left and right
13 Number of Tubiana Stage 1 digits	Total #, left and right
Total Severity Score	Total of above

Notes on Dupuytren Measurement systems
Charles Eaton MD Dupuytren Research Group Jan 2018

2008 Macionis: Generic | Objective | Profile (Tracing technique)

https://Dupuytren.org/DupPDFs/2008_Macionis.pdf

No validation reported.



2009 Smith: Generic | Objective | Profile (Photographic Goniometry)

https://Dupuytren.org/DupPDFs/2009_Smith.pdf

Analysis of lateral photos correlated well with goniometric measurements



2009 Hurst: Specific | Objective | Profile (Immediate treatment outcome)

https://Dupuytren.org/DupPDFs/2009_Hurst.pdf

Individual joint contracture ≥ 20 degrees treated; % of treated group corrected to ≤ 5 degrees.

Notes on Dupuytren Measurement systems
 Charles Eaton MD Dupuytren Research Group Jan 2018

2009 Degreef: Generic | Objective, Subjective | Review (Compare DASH, AMA Guides)

https://Dupuytren.org/DupPDFs/2009_Degreef2.pdf

http://www.orthopaedicscore.com/scorepages/disabilities_of_arm_shoulder_hand_score_das_h.html

“There was no significant correlation between the DASH score on one hand and the total flexion contracture, the mean flexion contraction/finger, the mean flexion contracture of the proximal interphalangeal (PIP), the mean flexion contracture of the metacarpophalangeal (MCP), the number of involved hands, fingers or joints, and the AMA impairment rating on the other hand”

2011 Beaudreuil: Generic | Subjective | Profile (URAM)

https://Dupuytren.org/DupPDFs/2011_Beaudreuil2.pdf

Table 5. English version of the Unité Rhumatologique des Affections de la Main (URAM) scale

Can you . . .	Without difficulty (0)	With very little difficulty (1)	With some difficulty (2)	With much difficulty (3)	Almost impossible (4)	Impossible (5)
1. Wash yourself with a flannel, keeping your hand flat?	<input type="checkbox"/>	<input type="checkbox"/>	<input type="checkbox"/>	<input type="checkbox"/>	<input type="checkbox"/>	<input type="checkbox"/>
2. Wash your face?	<input type="checkbox"/>	<input type="checkbox"/>	<input type="checkbox"/>	<input type="checkbox"/>	<input type="checkbox"/>	<input type="checkbox"/>
3. Hold a bottle in one hand?	<input type="checkbox"/>	<input type="checkbox"/>	<input type="checkbox"/>	<input type="checkbox"/>	<input type="checkbox"/>	<input type="checkbox"/>
4. Shake someone's hand?	<input type="checkbox"/>	<input type="checkbox"/>	<input type="checkbox"/>	<input type="checkbox"/>	<input type="checkbox"/>	<input type="checkbox"/>
5. Stroke something or caress someone?	<input type="checkbox"/>	<input type="checkbox"/>	<input type="checkbox"/>	<input type="checkbox"/>	<input type="checkbox"/>	<input type="checkbox"/>
6. Clap your hands?	<input type="checkbox"/>	<input type="checkbox"/>	<input type="checkbox"/>	<input type="checkbox"/>	<input type="checkbox"/>	<input type="checkbox"/>
7. Spread out your fingers?	<input type="checkbox"/>	<input type="checkbox"/>	<input type="checkbox"/>	<input type="checkbox"/>	<input type="checkbox"/>	<input type="checkbox"/>
8. Lean on your hand?	<input type="checkbox"/>	<input type="checkbox"/>	<input type="checkbox"/>	<input type="checkbox"/>	<input type="checkbox"/>	<input type="checkbox"/>
9. Pick up small objects with your thumb and index finger?	<input type="checkbox"/>	<input type="checkbox"/>	<input type="checkbox"/>	<input type="checkbox"/>	<input type="checkbox"/>	<input type="checkbox"/>

2011 Budd: Quickdash: Generic | Subjective | Profile

https://Dupuytren.org/DupPDFs/2011_Budd.pdf

Notes on Dupuytren Measurement systems
Charles Eaton MD Dupuytren Research Group Jan 2018

QuickDASH

Please rate your ability to do the following activities in the last week by circling the number below the appropriate response.

	NO DIFFICULTY	MILD DIFFICULTY	MODERATE DIFFICULTY	SEVERE DIFFICULTY	UNABLE
1. Open a tight or new jar.	1	2	3	4	5
2. Do heavy household chores (e.g., wash walls, floors).	1	2	3	4	5
3. Carry a shopping bag or briefcase.	1	2	3	4	5
4. Wash your back.	1	2	3	4	5
5. Use a knife to cut food.	1	2	3	4	5
6. Recreational activities in which you take some force or impact through your arm, shoulder or hand (e.g., golf, hammering, tennis, etc.).	1	2	3	4	5

	NOT AT ALL	SLIGHTLY	MODERATELY	QUITE A BIT	EXTREMELY
7. During the past week, to what extent has your arm, shoulder or hand problem interfered with your normal social activities with family, friends, neighbours or groups?	1	2	3	4	5

	NOT LIMITED AT ALL	SLIGHTLY LIMITED	MODERATELY LIMITED	VERY LIMITED	UNABLE
8. During the past week, were you limited in your work or other regular daily activities as a result of your arm, shoulder or hand problem?	1	2	3	4	5

Please rate the severity of the following symptoms in the last week. (circle number)

	NONE	MILD	MODERATE	SEVERE	EXTREME
9. Arm, shoulder or hand pain.	1	2	3	4	5
10. Tingling (pins and needles) in your arm, shoulder or hand.	1	2	3	4	5

	NO DIFFICULTY	MILD DIFFICULTY	MODERATE DIFFICULTY	SEVERE DIFFICULTY	SO MUCH DIFFICULTY THAT I CAN'T SLEEP
11. During the past week, how much difficulty have you had sleeping because of the pain in your arm, shoulder or hand? (circle number)	1	2	3	4	5

QuickDASH DISABILITY/SYMPTOM SCORE = $\left(\left[\frac{\text{sum of } n \text{ responses}}{n} \right] - 1 \right) \times 25$, where n is equal to the number of completed responses.

A QuickDASH score may not be calculated if there is greater than 1 missing item.

QuickDASH

WORK MODULE (OPTIONAL)

The following questions ask about the impact of your arm, shoulder or hand problem on your ability to work (including homemaking if that is your main work role).

Please indicate what your job/work is: _____

I do not work. (You may skip this section.)

Please circle the number that best describes your physical ability in the past week.

Did you have any difficulty:	NO DIFFICULTY	MILD DIFFICULTY	MODERATE DIFFICULTY	SEVERE DIFFICULTY	UNABLE
1. using your usual technique for your work?	1	2	3	4	5
2. doing your usual work because of arm, shoulder or hand pain?	1	2	3	4	5
3. doing your work as well as you would like?	1	2	3	4	5
4. spending your usual amount of time doing your work?	1	2	3	4	5

SPORTS/PERFORMING ARTS MODULE (OPTIONAL)

The following questions relate to the impact of your arm, shoulder or hand problem on playing your *musical instrument or sport or both*. If you play more than one sport or instrument (or play both), please answer with respect to that activity which is most important to you.

Please indicate the sport or instrument which is most important to you: _____

I do not play a sport or an instrument. (You may skip this section.)

Please circle the number that best describes your physical ability in the past week.

Did you have any difficulty:	NO DIFFICULTY	MILD DIFFICULTY	MODERATE DIFFICULTY	SEVERE DIFFICULTY	UNABLE
1. using your usual technique for playing your instrument or sport?	1	2	3	4	5
2. playing your musical instrument or sport because of arm, shoulder or hand pain?	1	2	3	4	5
3. playing your musical instrument or sport as well as you would like?	1	2	3	4	5
4. spending your usual amount of time practising or playing your instrument or sport?	1	2	3	4	5

SCORING THE OPTIONAL MODULES: Add up assigned values for each response; divide by 4 (number of items); subtract 1; multiply by 25.

An optional module score may **not** be calculated if there are any missing items.

Notes on Dupuytren Measurement systems
Charles Eaton MD Dupuytren Research Group Jan 2018

2011 Engstrand: Generic | Objective | Profile (Goniometry validation)
https://Dupuytren.org/DupPDFs/2012_Engstrand.pdf

Found high inter-rater reliability using short armed goniometer for dorsal measurements.
Commonly accepted level of measurement error of 5 degrees for goniometric measurement of joints in the hand.

2011 Jerosch-Herold: Generic | Objective, Subjective | Review (DASH vs.Goniometry)
https://Dupuytren.org/DupPDFs/2011_JeroschHerold1.pdf

Poor correlation between DASH and goniometry

2011 Pervulesko: Specific | Objective | Profile (Self-diagnosis)
https://Dupuytren.org/DupPDFs/2011_Pervulesko.pdf

1. Do you already have Dupuytren's disease diagnosed by a doctor?

Yes No

2. Do you have any flexion deformity in one or more fingers? "The flat hand test"

(If you are able to place both hands flat on a table top, then you have **no** flexion deformity – see picture below)



Yes No

3. Can you notice on one/or both of your palms and/or fingers some nodules or cords related to those in the pictures? (note: The affected area does not need to be identical with this in the pictures below)



Yes No

4. Do you suffer from any connective tissue disorder diagnosed by a doctor?

Yes No

If yes, what kind of? _____

Notes on Dupuytren Measurement systems
 Charles Eaton MD Dupuytren Research Group Jan 2018

2011 Trybus: Generic | Subjective | Profile
https://Dupuytren.org/DupPDFs/2011_Trybus.pdf

Answers were a 1-7 scale. These elements correlated with severity, but severity wasn't defined.
 Listed just to give ideas...

Subscale	Element
Self-esteem	my disease makes me less valuable
	due to my disease I feel less physically attractive, disfigured
	the look of my hand (hands) makes me feel ashamed and I try to hide it (them) from people's sight
Work	my disease makes my occupational performance worse
	due to my disease I am a less valuable worker to my managers
	because of my disability I am treated leniently by my colleagues at work and sometimes even helped with more precise operations
Social	people from my environment react in a negative way when seeing my hand (for example ridicule, distrust, are unwilling to shake hands)
	due to the disability (deformation) of my hand (hands) I avoid social occasions and feel worse in the presence of friends and colleagues
	due to the disability of my hand (hands), I have to restrict or change the way I spend my leisure time

2011 Witthaut: Specific | Objective, Subjective | Review (Subjective vs. goniometric improvement)
https://Dupuytren.org/DupPDFs/2011_Witthaut.pdf

Retrospectively determined 13.5 degrees as the minimum clinically important difference for patients to feel improved.

2012 Descatha Specific | Subjective | Profile Risk prediction vs. perceived manual exertion history (RPE))

https://Dupuytren.org/DupPDFs/2012_Descatha.pdf

Correlation of risk of Dupuytren disease and Activity rated by Borg Scale

- Heavy manual labor, defined as using hand tools \geq 2hr/day @ Borg scale \geq 15, or
- Use of vibrating hand tools \geq 2hr/day).

Rating of Perceived Exertion (RPE) Scale

Borg Scale 6-20)	Intensity	Breathing Scale	Distance Scale
6	No exertion at all		
7		Can sing full songs	Could continue all day
8	Extremely light		Could continue 4–6 hours
9	Very light	Can sing partial verses	Could continue 3–4 hours
10			Could continue 2–3 hours
11	Light	Can talk in full sentences	Could continue 1–2 hours
12			Could continue 45–60 minutes
13	Somewhat hard	Can talk in short sentences	Could continue 30–45 minutes
14			Could continue 20–30 minutes
15	Hard (heavy)	Breathing hard, thinking clearly	Could continue 15–20 minutes
16			Could continue 10–15 minutes
17	Very hard	Breakaway ventilation	Could continue 5–10 minutes
18			Could continue 2–5 minutes
19	Extremely hard		Could continue 1–2 minutes
20	Maximal exertion		Could continue <1 minute

© Duplication of © Gunner Borg, 1970, 1985, 1994, 1998.

Notes on Dupuytren Measurement systems
Charles Eaton MD Dupuytren Research Group Jan 2018

2012 Matton and Eaton: Generic | Objective | Profile (Wire Goniometer)
https://Dupuytren.org/DupPDFs/2012_Matton.pdf

Labelled flat wires for mailing, patient sends photo of bent wires on a single sheet:

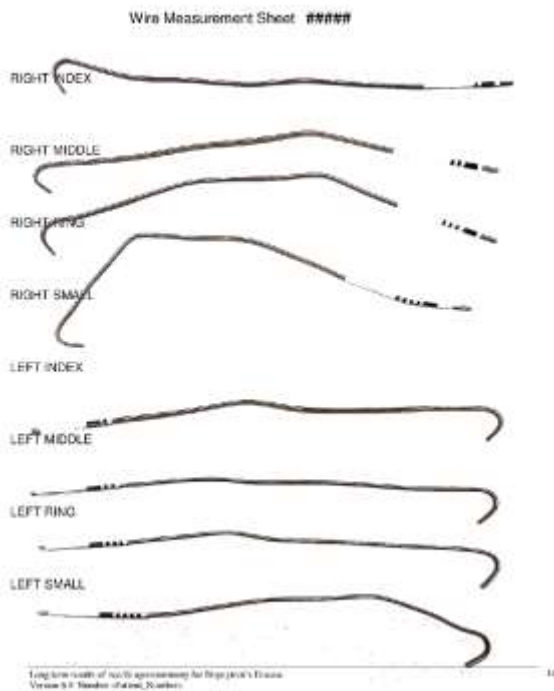
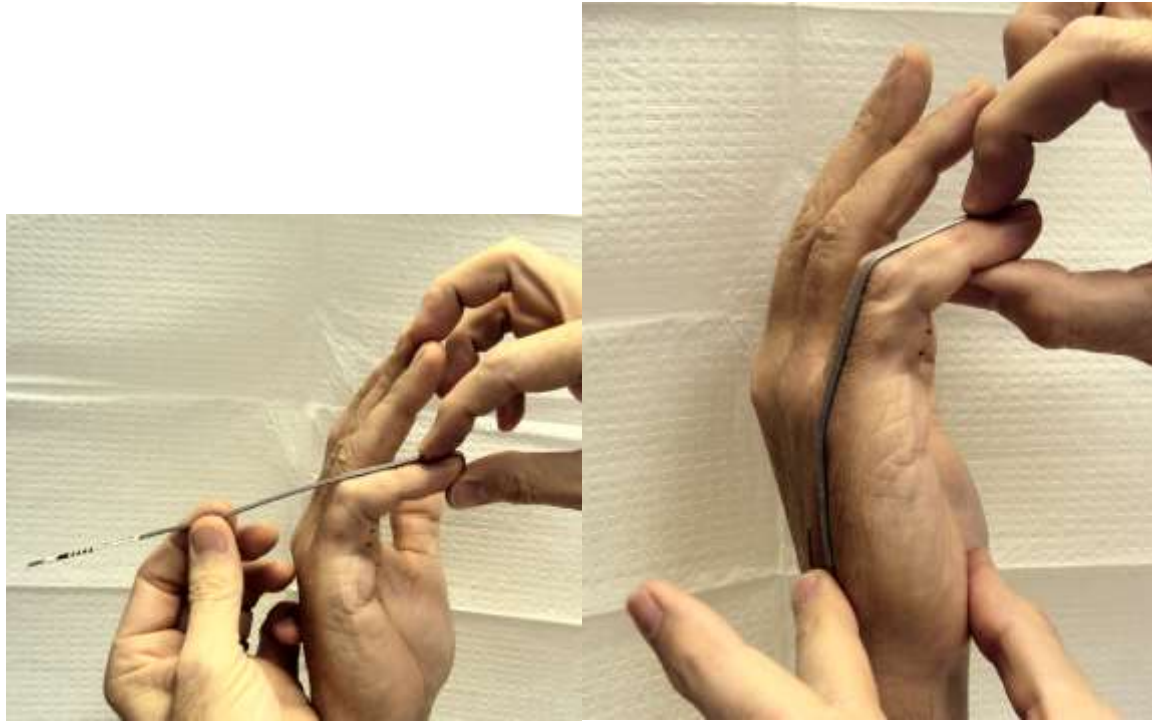

Costly and time consuming.

Notes on Dupuytren Measurement systems
Charles Eaton MD Dupuytren Research Group Jan 2018

2013 Macionis: Generic | Objective | Profile (Paper goniometer)
https://Dupuytren.org/DupPDFs/2008_Macionis.pdf

Advantage for severe contractures

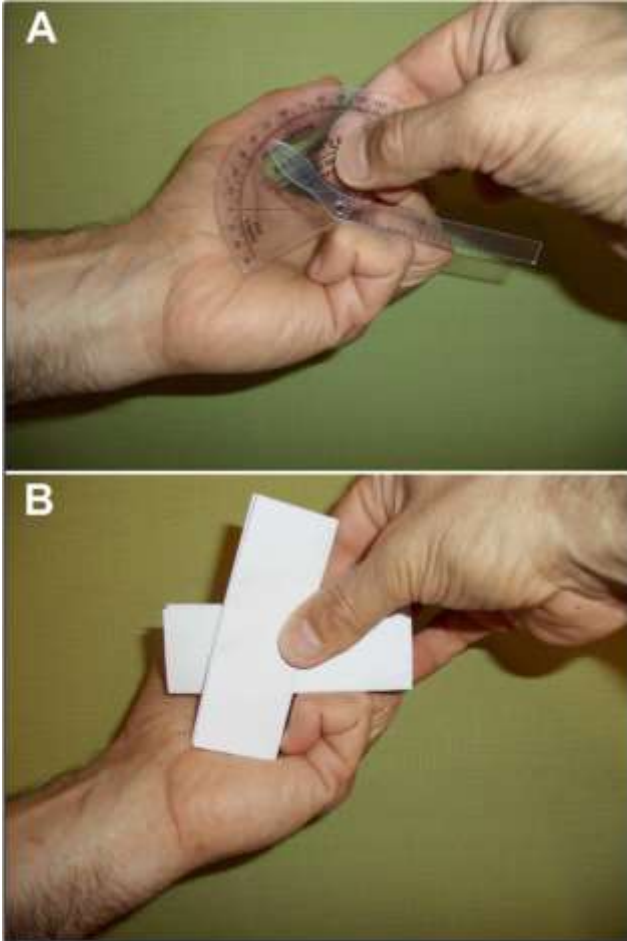

Notes on Dupuytren Measurement systems
Charles Eaton MD Dupuytren Research Group Jan 2018

2013 Ball: [Generic](#) | [Objective, Subjective](#) | [Review](#)
https://Dupuytrens.org/DupPDFs/2013_Ball.pdf

No consensus on standard clinical disease assessment

- ROM
 - Flexion contracture
 - Joint extension deficit
 - Active flexion and extension of joint
 - Tubiana Grading system
 - Author defined category
 - Passive extension deficit
 - Fixed flexion deformity
 - Total Active Motion
 - Flexion deformity
 - Composite flexion
 - Flexion deficit
 - Extension contracture
 - Total lack of active extension
 - Percentage change
 - Total digital extension
 - Total active extension deficit
 - Total lack of active flexion
- Strength
 - Grip
 - Pinch
- Sensibility
 - 2 Point Discrimination
 - Semmes-Weinstein monofilaments
- Patient Reported Measures
 - DASH
 - QuickDASH
 - MHQ
 - URAM
- Patient Satisfaction – not consistent

Recommendations: use a combination of

- Region specific questionnaire
- PROM
- Objective measures of ROM, grip, sensibility
- Some definition of recurrence

Notes on Dupuytren Measurement systems
Charles Eaton MD Dupuytren Research Group Jan 2018

2013 Bot: Generic | Subjective | Review (Web vs paper forms for self-reported hand data)
https://Dupuytren.org/DupPDFs/2013_Bot.pdf

Concluded that for QuickDASH, PHQ-2, PCS-6, and PSEQ, web based forms were equivalent to paper based forms.

2013 Gu: Generic | Subjective | Profile (speculated disability based on hand pictures)
https://Dupuytren.org/DupPDFs/2013_Gu.pdf

Really?

2013 Kan: Specific | Objective | Review (Definitions of recurrence)
<http://www.ncbi.nlm.nih.gov/pubmed/23137947>

- Based on nodules or cords
 - Regardless of treated area
 - In Treated area
- Based on degree of contracture
- Repeated treatment
- Self-reported
 - Beginning to recur
 - Correction lost

Concluded: no consensus

Notes on Dupuytren Measurement systems
 Charles Eaton MD Dupuytren Research Group Jan 2018

2013 Pearl: Generic | Subjective | Profile Generic (3 dimensional assessment)
<http://www.ncbi.nlm.nih.gov/pubmed/24025292>

Modified version used for IDDB

Severity (score)	None (0)	Minor (1)	Moderate (2)	Major (3)
<i>Function:</i>	Normal	Minor difficulties	Moderate difficulties	Major difficulties
How well do your hand(s) work?	<ul style="list-style-type: none"> My hand(s) work and move normally 	<ul style="list-style-type: none"> Occasional or minor problem Some weakness, stiffness or numbness Clumsy or slower to perform some tasks 	<ul style="list-style-type: none"> Restricted use Unable to perform some tasks Substitution of other hand for some tasks 	<ul style="list-style-type: none"> Hand(s) have little or no useful function Other hand used for most or all tasks Assistance required
<i>Pain and tenderness:</i>	Normal	Minor discomfort	Moderate discomfort	Major discomfort
How much pain or tenderness do you have in your hand(s)?	<ul style="list-style-type: none"> No pain or tenderness 	<ul style="list-style-type: none"> Minor pain or tenderness Occurs only during heavy work or activities (sport, gardening, DIY) 	<ul style="list-style-type: none"> Moderate pain or tenderness Occurs during normal daytime activities (driving, writing, cooking, dressing) 	<ul style="list-style-type: none"> Severe pain or tenderness Occurs when resting and/or disturbs sleep
<i>Appearance:</i>	Normal	Minor deformity	Moderate deformity	Major deformity
Do your hand(s) look normal?	<ul style="list-style-type: none"> My hand(s) look normal 	<ul style="list-style-type: none"> Not obvious to others in social situations Minor self-consciousness 	<ul style="list-style-type: none"> Deformity visible in social situations Occasional glances or comments Moderate self-consciousness 	<ul style="list-style-type: none"> Obvious deformity visible in any situation Frequent glances, comments or teasing Prefer to keep hand hidden

Figure 1 Pre/postoperative questionnaire

2013 Van Vliet: Generic | Subjective | Review
https://Dupuytren.org/DupPDFs/2013_VanVliet.pdf

Found PRMs Boston Carpal Tunnel Questionnaire (BCTQ function and BCTQ symptom severity), quickDASH, and SF-8 had very different profiles for DD compared to COT syndromes (Carpal tunnel, Osteoarthritis, Tenosynovitis).

Notes on Dupuytren Measurement systems
Charles Eaton MD Dupuytren Research Group Jan 2018

2013 Wilburn: Generic | Subjective | Review (QOL vs. activity limitations)
https://Dupuytren.org/DupPDFs/2013_Wilburn.pdf

- Activity Limitations:
 - Dressing
 - Writing
 - Shaking Hands
 - Jobs around the house
 - Employment
 - Hobbies
 - Gripping/holding/opening
 - Carrying
 - Lifting
 - Personal care
- Quality of life- needs:
 - Physiologic: rest
 - Safety/security: Strength; hygiene; confidence in strength;dexterity;limited/slow activities
 - Social: shaking hands;participation with family/friends;social interaction;communication;planning;handling money
 - Affection: intimacy;relationships
 - Esteem: Self-confidence;emotional stability;appearance;independence
 - Cognitive: concentration; interests/hobbies; reading

2013 Mohan Generic | Subjective | Profile (Southampton Dupuytren's Scoring Scheme)

2013 Kan: Specific | Objective | Profile (Recurrence)
https://Dupuytren.org/DupPDFs/2013_Kan.pdf

Defined recurrence of Dupuytren's disease as "an increase in joint contracture in any treated joint of at least 20 degrees at one year posttreatment compared to six weeks post-treatment. In addition, it is recommended to repeat measurements yearly and to report recurrence for all treated joints individually."

Notes on Dupuytren Measurement systems
Charles Eaton MD Dupuytren Research Group Jan 2018

2014 Westacott Generic | Objective | Profile (Visual record)

https://Dupuytren.org/DupPDFs/2014_Westacott.pdf

recommended following contact area of palm on surface as shown. Could also photocopy hand



2015 Akhavan: Generic | Objective | Review

https://Dupuytren.org/DupPDFs/2015_Akhavan.pdf

No universal Dupuytren classification system exists

2015 Rodrigues: Generic | Subjective | Review

https://Dupuytren.org/DupPDFs/2015_Rodrigues.pdf

Evaluated DASH and Quickdash: recommended adding pain evaluation

Unpublished

Eaton: Generic | Objective | Profile (PROM; Tracing)

Independently developed a system similar to Macionis. Did not pass validation testing:



Notes on Dupuytren Measurement systems
Charles Eaton MD Dupuytren Research Group Jan 2018

Eaton: [Generic](#) | [Objective](#) | [Profile \(PROM; Self-reported online goniometer\)](#)

Patients move fingers on the screen to match their own. Has not undergone validation testing.

Dupuytren Contracture Finger Angle Measurer

Side view:
the fingers of
your LEFT hand.
**Click on a joint
to select it.**
Move the ball
at the tip
to move the joint.
**Click on the ball
to stop moving.**

Click words to
change view or
reset angles.

[Index View](#) [Reset](#)
[Middle View](#) [Reset](#)
[Ring View](#) [Reset](#)
[Small View](#) [Reset](#)
[All View](#) [Reset](#)

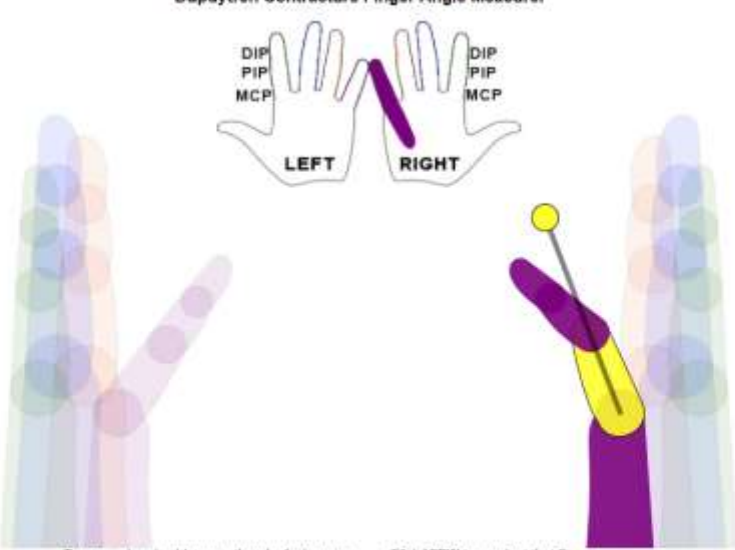

Turn your hands sideways, thumbs facing you.
Make the back of your hand vertical
(line it up with the side of your screen).
straighten your fingers as much as you can
move the cartoon fingers to match yours.

Click **VIEW** to see just that finger.
Click **RESET** to reset all joints for that finger.
Click **SLIDERS** to show or hide slider controls.
Click **HELP** for help.

2/5/2018 7:24 AM

Side view:
the fingers of
your RIGHT hand.
**Click on a joint
to select it.**
Move the ball
at the tip
to move the joint.
**Click on the ball
to stop moving.**

Click words to
change view or
reset angles.

[Reset View Index](#)
[Reset View Middle](#)
[Reset View Ring](#)
[Reset View Small](#)
[Reset View All](#)

Lenze: [Generic](#) | [Objective](#) | [Profile \(PROM; Printed paper protractor\)](#)

Has not undergone validation testing

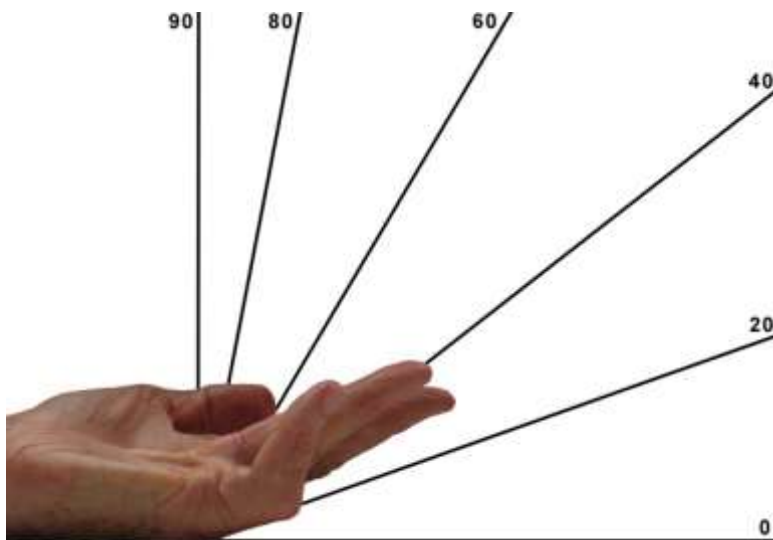

Notes on Dupuytren Measurement systems
Charles Eaton MD Dupuytren Research Group Jan 2018

Lubahn: Generic | Objective | Profile (PROM; Analogue wall clock as protractor)
Has not undergone validation testing



Raskin: Generic | Objective | Profile (Curved table-top test)
Has not undergone validation testing

Fit the palm to a standard angled surface

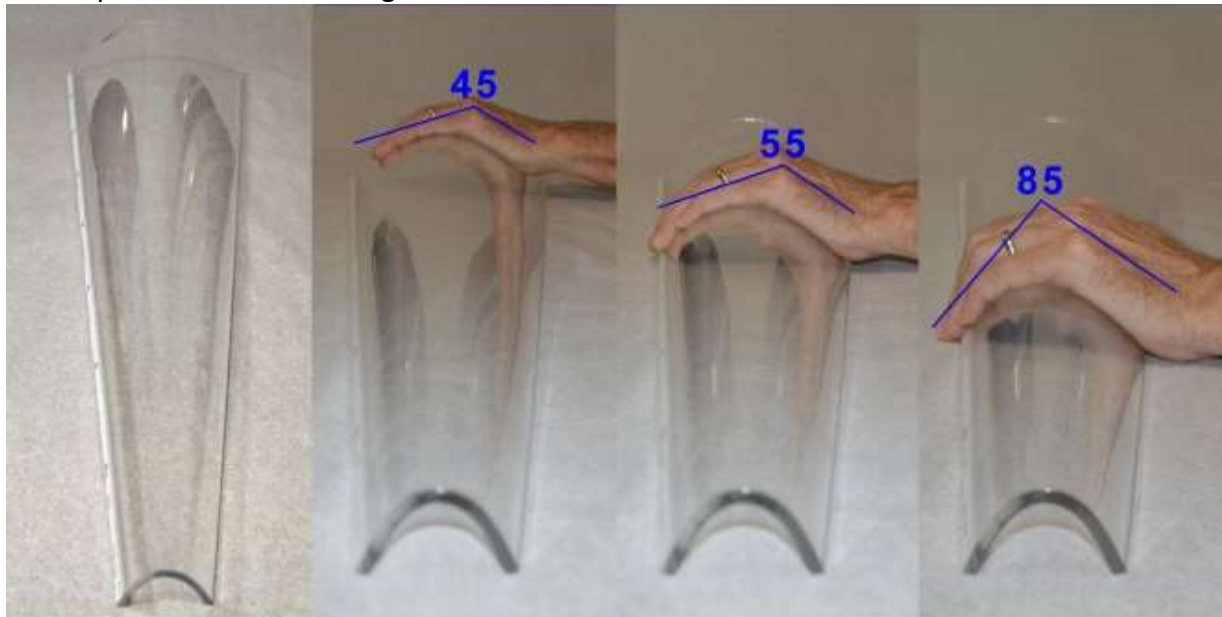

Notes on Dupuytren Measurement systems
Charles Eaton MD Dupuytren Research Group Jan 2018

References

- Meyerding HW. (1936). "DUPUYTREN'S CONTRACTURE." Archives of Surgery 32 (2): 320–33. <http://archsurg.jamanetwork.com/article.aspx?doi=10.1001/archsurg.1936.01180200142007>.
https://Dupuytren.org/DupPDFs/1936_Meyerding.pdf
- Einarsson F. (1946). "On the Treatment of Dupuytren's Contracture." Acta Chirurgica Scandinavica 93 (1): 1–22. <http://www.ncbi.nlm.nih.gov/pubmed/21015410>.
https://Dupuytren.org/DupPDFs/1946_Einarsson.pdf
- Skoog T. (1948). "Chapter 8. General Survey." Skoog, T: Dupuytren's Contraction With Special Reference To Aetiology And Improved Surgical Treatment Its Occurrence In Epileptics Note On Knuckle-Pads. Acta Chirurgica Scandinavica 1948;vol 96, Suppl 139.
https://Dupuytren.org/DupPDFs/1948_Skoog08.pdf
- Iselin M, Iselin F. (1967). "MALADIE DE DUPUYTREN (Chapter XXI)." In Iselin M, Iselin F: Traité de Chirurgie de La Main. Éditions Médicales Flammarion, Paris, 667–713.
https://Dupuytren.org/DupPDFs/1967_Iselin.pdf
- McIndoe A, Beare RL. (1958). "The Surgical Management of Dupuytren's Contracture." American Journal of Surgery 95 (2): 197–203. <http://www.ncbi.nlm.nih.gov/pubmed/13487940>.
https://Dupuytren.org/DupPDFs/1958_McIndoe.pdf
- Howard LD. (1959). "Dupuytren's Contracture: A Guide for Management." Clinical Orthopaedics 15: 118–26. <http://www.ncbi.nlm.nih.gov/pubmed/14403457>.
https://Dupuytren.org/DupPDFs/1959_Howard.pdf
- Davis JE. (1965). "On Surgery of Dupuytren's Contracture." Plastic and Reconstructive Surgery 36 (3): 277–314. <http://www.ncbi.nlm.nih.gov/pubmed/5318808>.
https://Dupuytren.org/DupPDFs/1965_Davis.pdf
- Tubiana R, Michon J, Thomine JM. (1968). "Scheme for the Assessment of Deformities in Dupuytren's Disease." The Surgical Clinics of North America 48 (5): 979–84.
<http://www.ncbi.nlm.nih.gov/pubmed/5683795>.
https://Dupuytren.org/DupPDFs/1968_Tubiana.pdf
- Honner R, Lamb DW, James JJ. (1971). "Dupuytren's Contracture. Long Term Results after Fasciectomy." The Journal of Bone and Joint Surgery. British Volume 53 (2). Berlin/Heidelberg: Springer-Verlag: 240–46.
http://www.springerreference.com/index/doi/10.1007/SpringerReference_40904.
- Johnson HA. (1980). "The Hugh Johnson Sign of Early Dupuytren's Contracture." Plast Reconstr Surg 65 (5): 697. https://Dupuytren.org/DupPDFs/1980_Johnson.pdf

Notes on Dupuytren Measurement systems
Charles Eaton MD Dupuytren Research Group Jan 2018

Legge JW, McFarlane RMM. (1980). "Prediction of Results of Treatment of Dupuytren's Disease." *The Journal of Hand Surgery* 5 (6): 608–16.

<http://www.ncbi.nlm.nih.gov/pubmed/7430610>.

https://Dupuytren.org/DupPDFs/1980_Legge_1023.pdf

Mäkelä EA, Jaroma H, Harju A, Anttila S, Vainio J. (1991). "Dupuytren's Contracture: The Long-Term Results after Day Surgery." *Journal of Hand Surgery (Edinburgh, Scotland)* 16 (3): 272–74.

<http://www.ncbi.nlm.nih.gov/pubmed/1960492>.

https://Dupuytren.org/DupPDFs/1991_Makela.pdf

Sollerman C, Ejeskär A. (1995). "Sollerman Hand Function Test. A Standardised Method and Its Use in Tetraplegic Patients." *Scandinavian Journal of Plastic and Reconstructive Surgery and Hand Surgery* 29 (2): 167–76. <http://www.ncbi.nlm.nih.gov/pubmed/7569815>.

https://Dupuytren.org/DupPDFs/1995_Sollerman.pdf

Woodruff MJ, Waldram MA. (1998). "A Clinical Grading System for Dupuytren's Contracture." *J Hand Surg Br* 23 (3): 303–5. https://Dupuytren.org/DupPDFs/1998_Woodruff.pdf

Chung KC, Pillsbury MS, Walters MR, Hayward Ra. (1998). "Reliability and Validity Testing of the Michigan Hand Outcomes Questionnaire." *The Journal of Hand Surgery* 23 (4): 575–87.

<http://www.ncbi.nlm.nih.gov/pubmed/9708370>.

https://Dupuytren.org/DupPDFs/1998_Chung.pdf

Dias JJ, Bhowal B, Wildin CJ, Thompson JR. (2001). "Assessing the Outcome of Disorders of the Hand. Is the Patient Evaluation Measure Reliable, Valid, Responsive and without Bias?" *The Journal of Bone and Joint Surgery. British Volume* 83 (2): 235–40.

<http://www.ncbi.nlm.nih.gov/pubmed/11284572>.

https://Dupuytren.org/DupPDFs/2001_Dias.pdf

Dias JJ, Braybrooke J. (2006). "Dupuytren's Contracture: An Audit of the Outcomes of Surgery." *Journal of Hand Surgery (Edinburgh, Scotland)* 31 (5): 514–21.

<http://www.ncbi.nlm.nih.gov/pubmed/16837113>.

https://Dupuytren.org/DupPDFs/2006_Dias.pdf

Hindocha S, Stanley JK, Watson JS, Bayat A. (2008). "Revised Tubiana's Staging System for Assessment of Disease Severity in Dupuytren's Disease-Preliminary Clinical Findings." *Hand (NY)* 3 (2): 6–80. <http://www.ncbi.nlm.nih.gov/pubmed/18780081>.

https://Dupuytren.org/DupPDFs/2008_Hindocha_1014.pdf

Stam HJ, Ardon MS, den Ouden AC, Schreuders TAR, Roebroek ME. (2006). "The Compangle: A New Goniometer for Joint Angle Measurements of the Hand. A Technical Note." *Europa Medicophysica* 42 (1): 37–40. <http://www.ncbi.nlm.nih.gov/pubmed/16565684>.

https://Dupuytren.org/DupPDFs/2006_Stam.pdf

Notes on Dupuytren Measurement systems
Charles Eaton MD Dupuytren Research Group Jan 2018

van Rijssen AL, Werker PMN. (2006). "Percutaneous Needle Fasciotomy in Dupuytren's Disease." *Journal of Hand Surgery (Edinburgh, Scotland)* 31 (5): 498–501.
<http://www.ncbi.nlm.nih.gov/pubmed/16766101>.

Kato Masami, Echigo Ayumu, Ohta Hisaaki, Ishiai Sumio, Aoki Mitsuhiro, Tsubota Sadako, Uchiyama Eiichi. (2007). "The Accuracy of Goniometric Measurements of Proximal Interphalangeal Joints in Fresh Cadavers: Comparison between Methods of Measurement, Types of Goniometers, and Fingers." *Journal of Hand Therapy : Official Journal of the American Society of Hand Therapists* 20 (1): 12–8; quiz 19.
<http://www.ncbi.nlm.nih.gov/pubmed/17254904>.
https://Dupuytren.org/DupPDFs/2007_Kato.pdf

Zyluk A, Jagielski W. (2007). "The Effect of the Severity of the Dupuytren's Contracture on the Function of the Hand before and after Surgery." *The Journal of Hand Surgery, European Volume* 32 (3): 326–29. <http://www.ncbi.nlm.nih.gov/pubmed/17335947>.
https://Dupuytren.org/DupPDFs/2007_Zyluk.pdf

Macionis Valdas. (2008). "A Technique of Direct Tracing for Recording Digital Range of Motion." *The Journal of Hand Surgery* 33 (4): 612–14. <http://www.ncbi.nlm.nih.gov/pubmed/18406967>.
https://Dupuytren.org/DupPDFs/2008_Macionis.pdf

Smith RP, Dias JJ, Ullah A, Bhowal B. (2009). "Visual and Computer Software-Aided Estimates of Dupuytren's Contractures: Correlation with Clinical Goniometric Measurements." *Annals of the Royal College of Surgeons of England* 91 (4): 296–300.
<http://www.ncbi.nlm.nih.gov/pubmed/19220942>.
https://Dupuytren.org/DupPDFs/2009_Smith.pdf

Hurst Lawrence C, Badalamente Marie A, Hentz Vincent R, Hotchkiss Robert N, Kaplan F Thomas D, Meals Roy A, Smith Theodore M, Rodzvilla John, CORD I Study Group. (2009). "Injectable Collagenase Clostridium Histolyticum for Dupuytren's Contracture." *The New England Journal of Medicine* 361 (10): 968–79. <http://www.ncbi.nlm.nih.gov/pubmed/19726771>.
https://Dupuytren.org/DupPDFs/2009_Hurst.pdf

Degreef I, Vererfve PB, De Smet L, Surgery Orthopaedic, Pellenberg UZ. (2009). "Effect of Severity of Dupuytren Contracture on Disability ." *Scand J Plast Reconstr Surg Hand Surg* 43 (1): 2–41. <http://www.ncbi.nlm.nih.gov/pubmed/19153881>.
https://Dupuytren.org/DupPDFs/2009_Degreef2.pdf

Beaudreuil Johann, Allard Anne, et al. (2011). "Unité Rhumatologique Des Affections de La Main (URAM) Scale: Development and Validation of a Tool to Assess Dupuytren's Disease-Specific Disability." *Arthritis Care & Research* 63 (10): 1448–55.
<http://www.ncbi.nlm.nih.gov/pubmed/21786431>.
https://Dupuytren.org/DupPDFs/2011_Beaudreuil2.pdf

Notes on Dupuytren Measurement systems
Charles Eaton MD Dupuytren Research Group Jan 2018

Budd Henry R, Larson Debbie, Chojnowski Adrian, Shepstone Lee. (2011). "The QuickDASH Score: A Patient-Reported Outcome Measure for Dupuytren's Surgery." *Journal of Hand Therapy : Official Journal of the American Society of Hand Therapists* 24 (1): 15–20; quiz 21. <http://www.ncbi.nlm.nih.gov/pubmed/21106346>.
https://Dupuytren.org/DupPDFs/2011_Budd.pdf

Engstrand C, Krevers B, Kvist J. (2011). "Interrater Reliability in Finger Joint Goniometer Measurement in Dupuytren's Disease ." *American Journal of Occupational Therapy* 66 (1): 98–103. https://Dupuytren.org/DupPDFs/2012_Engstrand.pdf

Jerosch-Herold C, Shepstone L, Chojnowski A, Larson D. (2011). "Severity of Contracture and Self-Reported Disability in Patients with Dupuytren's Contracture Referred for Surgery." *J Hand Ther* 24 (1): 6–10; quiz 11. https://Dupuytren.org/DupPDFs/2011_JeroschHerold1.pdf

Pervulesko N, Schoffl V, Gormasz C. (2011). "Evaluation of a Self-Diagnostic Tool for Dupuytren's Disease in Rock Climbers." *Hand Therapy* 16 (2): 45–48.
https://Dupuytren.org/DupPDFs/2011_Pervulesko.pdf

Trybus Marek, Bednarek Marcin, Lorkowski Jacek, Teul Iwona. (2011). "Psychologic Aspects of Dupuytren's Disease: A New Scale of Subjective Well-Being of Patients." *Annales Academiae Medicae Stetinensis* 57 (1): 31–7; discussion 37.
<http://www.ncbi.nlm.nih.gov/pubmed/22593988>.
https://Dupuytren.org/DupPDFs/2011_Trybus.pdf

Witthaut Jörg, Bushmakin Andrew G, Gerber Robert a, Cappelleri Joseph C, Le Graverand-Gastineau Marie Pierre Hellio. (2011). "Determining Clinically Important Changes in Range of Motion in Patients with Dupuytren's Contracture: Secondary Analysis of the Randomized, Double-Blind, Placebo-Controlled CORD I Study." *Clinical Drug Investigation* 31 (11): 791–98.
<http://link.springer.com/10.1007/BF03256918>.
https://Dupuytren.org/DupPDFs/2011_Witthaut.pdf

Descatha A, Bodin J, Ha C, Goubault P, Lebreton M, Chastang JF, Imbernon E, Leclerc A, Goldberg M, Roquelaure Y. (2012). " Heavy Manual Work, Exposure to Vibration and Dupuytren's Disease? Results of a Surveillance Program for Musculoskeletal Disorders ." *Occup Environ Med* 69 (4): 29–296. <http://www.ncbi.nlm.nih.gov/pubmed/22213840>.
https://Dupuytren.org/DupPDFs/2012_Descatha.pdf

Matton Alix. (2012). "Long Term Retreatment Rate of Dupuytren's Disease after Percutaneous Needle Fasciotomy. Bachelor Thesis IBMG."
https://Dupuytren.org/DupPDFs/2012_Matton.pdf

Macionis Valdas. (2013). "Reliability of the Standard Goniometry and Diagrammatic Recording of Finger Joint Angles: A Comparative Study with Healthy Subjects and Non-Professional

Notes on Dupuytren Measurement systems
Charles Eaton MD Dupuytren Research Group Jan 2018

Raters." BMC Musculoskeletal Disorders 14 (1).
https://Dupuytren.org/DupPDFs/2013_Macionis.pdf

Ball Catherine, Pratt Anna L, Nanchahal Jagdeep. (2013). "Optimal Functional Outcome Measures for Assessing Treatment for Dupuytren's Disease: A Systematic Review and Recommendations for Future Practice." BMC Musculoskeletal Disorders 14 (April): 131.
<http://www.ncbi.nlm.nih.gov/pubmed/23575442>.
https://Dupuytren.org/DupPDFs/2013_Ball.pdf

Bot Arjan GJ, Menendez Mariano E, Neuhaus Valentin, Mudgal Chaitanya S, Ring David. (2013). "The Comparison of Paper- and Web-Based Questionnaires in Patients with Hand and Upper Extremity Illness ." Hand 8 (2): 210–14. <http://link.springer.com/10.1007/s11552-013-9511-z>.
https://Dupuytren.org/DupPDFs/2013_Bot.pdf

Gu Ning Yan, Botteman Marc F, et al. (2013). "Eliciting Health State Utilities for Dupuytren's Contracture Using a Discrete Choice Experiment." Acta Orthopaedica 84 (6): 571–78.
https://Dupuytren.org/DupPDFs/2013_Gu.pdf

Kan Hester J, Verrijp Frank W, Huisstede Bionka MA, Hovius Steven ER, van Nieuwenhoven Christianne A, Selles Ruud W. (2013). "The Consequences of Different Definitions for Recurrence of Dupuytren's Disease." Journal of Plastic, Reconstructive & Aesthetic Surgery : JPRAS 66 (1): 95–103. <http://www.ncbi.nlm.nih.gov/pubmed/23137947>.

Pearl RA, Belcher HJCR. (2013). "Three-Dimensional Assessment of Hand Outcome." Annals of the Royal College of Surgeons of England 95 (6): 421–26.
<http://www.ncbi.nlm.nih.gov/pubmed/24025292>.

Van Vliet MM, Maradey JA, Homa KA, Kerrigan CL. (2013). "The Usefulness of Patient-Reported Measures for Clinical Practice ." Plast Reconstr Surg 132 (1): 12–105.
<http://www.ncbi.nlm.nih.gov/pubmed/23508051>.
https://Dupuytren.org/DupPDFs/2013_VanVliet.pdf

Wilburn J, McKenna SP, Perry-Hinsley D, Bayat A. (2013). "The Impact of Dupuytren Disease on Patient Activity and Quality of Life." J Hand Surg Am 38 (6). Elsevier Inc.: 1209–14.
<http://www.ncbi.nlm.nih.gov/pubmed/23508051> https://Dupuytren.org/DupPDFs/2013_Wilburn.pdf

Kan Hester J, Verrijp Frank W, Huisstede Bionka MA, Hovius Steven ER, van Nieuwenhoven Christianne A, Selles Ruud W. (2013). "The Consequences of Different Definitions for Recurrence of Dupuytren's Disease." Journal of Plastic, Reconstructive & Aesthetic Surgery : JPRAS 66 (1): 95–103. <http://www.ncbi.nlm.nih.gov/pubmed/23137947>.
https://Dupuytren.org/DupPDFs/2013_Kan.pdf

Notes on Dupuytren Measurement systems
Charles Eaton MD Dupuytren Research Group Jan 2018

Mohan Arvind, Vadher Jane, Ismail Hiba, Warwick David. (2013). "The Southampton Dupuytren's Scoring Scheme." *Journal of Plastic Surgery and Hand Surgery* 48 (1): 28–33.
https://Dupuytren.org/DupPDFs/2013_Mohan.pdf

Westacott DJ, Smith EW, Nwachukwu IA. (2014). "A Novel Method for Community Monitoring of Flexion Contracture in Dupuytren's Disease." *Annals of the Royal College of Surgeons of England* 96 (3): 240. <http://www.ncbi.nlm.nih.gov/pubmed/24780795>.
https://Dupuytren.org/DupPDFs/2014_Westacott.pdf

Akhavani Ma, McMurtrie a, Webb M, Muir L. (2015). "A Review of the Classification of Dupuytren's Disease." *Journal of Hand Surgery (European Volume)* 40 (2): 155–65.
<http://jhs.sagepub.com/cgi/doi/10.1177/1753193414560511>.
https://Dupuytren.org/DupPDFs/2015_Akhavani.pdf

Rodrigues J, Zhang W, Scammell B, Russell P, Chakrabarti I, Fullilove S, Davidson D, Davis T. (2015). "Validity of the Disability of the Arm, Shoulder and Hand Patient-Reported Outcome Measure (DASH) and the Quickdash When Used in Dupuytren's Disease." *Journal of Hand Surgery (European Volume)*. <http://jhs.sagepub.com/cgi/doi/10.1177/1753193415601350>.
https://Dupuytren.org/DupPDFs/2015_Rodrigues.pdf